

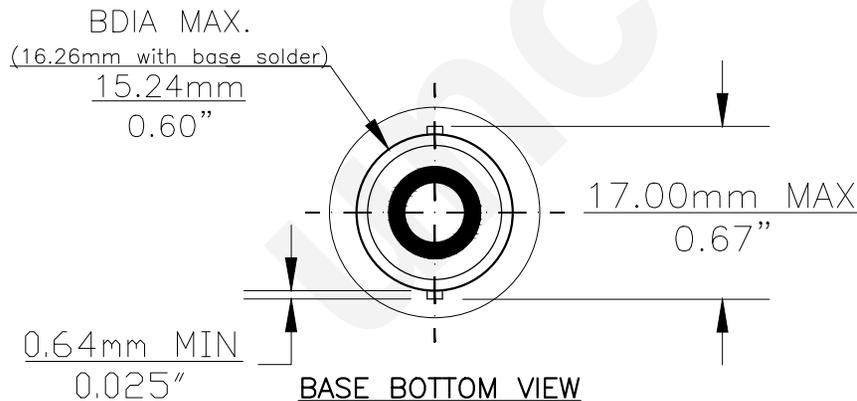

PART NO.	BASE TYPE	DESIGN VOLTS	DESIGN AMPS	MSCD	FILAMENT TYPE	AVERAGE LIFE HOURS	REVISIONS			
							REV #	DESCRIPTION	DATE	APPROVED
6S6SC/48V	S.C. Bayonet (BA15s)	48.0V	0.13±5%	--	C-7A	1500	1	ISSUED	11/10/2014	R.M.

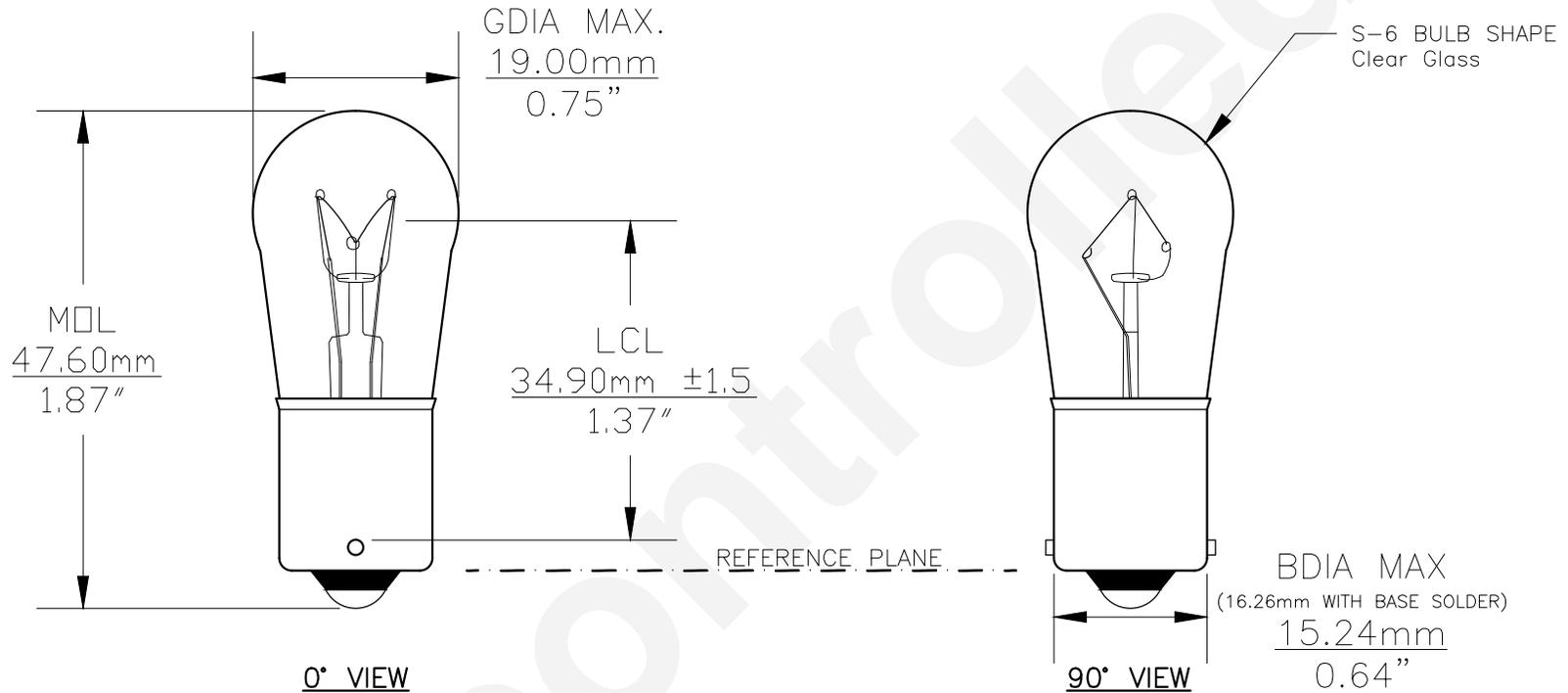

Note: Made according to SAE specifications



UNLESS OTHERWISE SPECIFIED: DIMENSIONS ARE IN INCHES TOLERANCES		CEC INDUSTRIES LTD			
DECIMALS	ANGULAR	599 BOND STREET		LINCOLNSHIRE, IL 60069	
.XX ± .05	± 0.5°	TITLE LIGHT BULB NO. 6S6SC/48V			
.XXX ± .010	± 1/64	SIZE A	FSCM NO.	DWG NO. 6S6SC/48V	REV 1
FRACTIONAL		DESIGN	SCALE	PLOT SCALE	SHEET 1 OF 1
		MATERIAL	FILE 6S6SC48V.pdf	DRAWING NOT TO SCALE	