

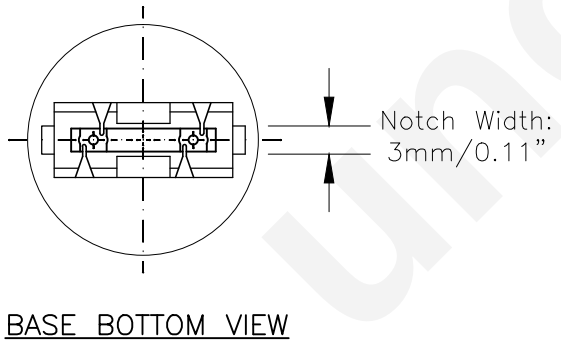

PART NO.	BASE TYPE	DESIGN VOLTS	DESIGN AMPS	MSCD	FILAMENT TYPE	AVERAGE LIFE HOURS	REVISIONS			
							REV #	DESCRIPTION	DATE	APPROVED
4057LL	D.F. Plastic Wedge W2.5X16q	12.8V 14.0V	2.23±5% 0.48±8%	32 ±10% 2 ±12%	C-6 C-6	4000 10000	1	ISSUED	04/01/2013	D.C.
							2	ADDED FILAMENT DISTANCE DIMENSIONS	10/04/2018	R.M.

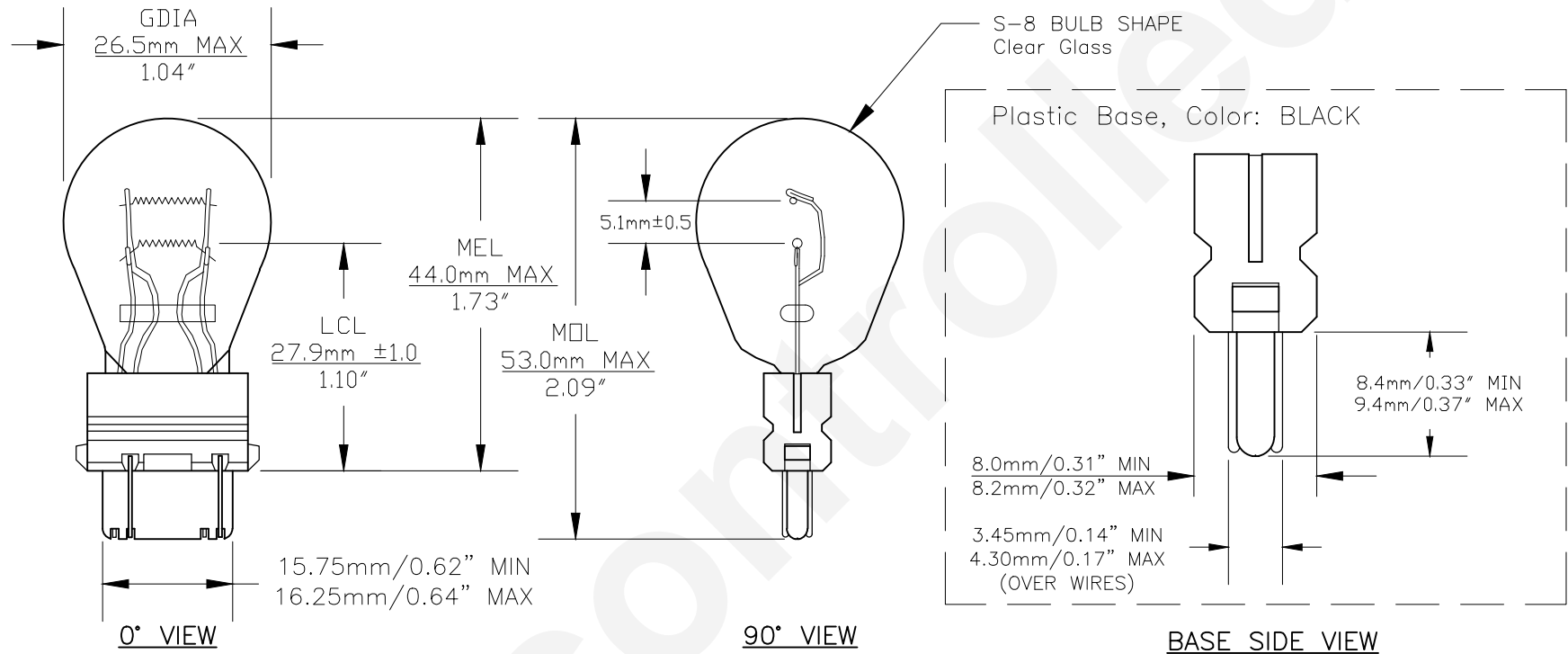

Note: Made according to SAE specifications

UNLESS OTHERWISE SPECIFIED: DIMENSIONS ARE IN INCHES TOLERANCES		CEC INDUSTRIES LTD			
DECIMALS	ANGULAR	599 BOND STREET		LINCOLNSHIRE, IL 60069	
.XX ± .05	± 0.5°				
.XXX ± .010					
FRACTIONAL	±1/64				
DRAWN D. C.	DATE 04/01/2013	TITLE LIGHT BULB NO. 4057LL			
CHECKED	SIZE A	FSCM NO.	DWG NO. 4057LL	REV 2	
DESIGN	SCALE	PLOT SCALE	SHEET 1 OF 1		
MATERIAL	FILE 4057LL.pdf	DRAWING NOT TO SCALE			