

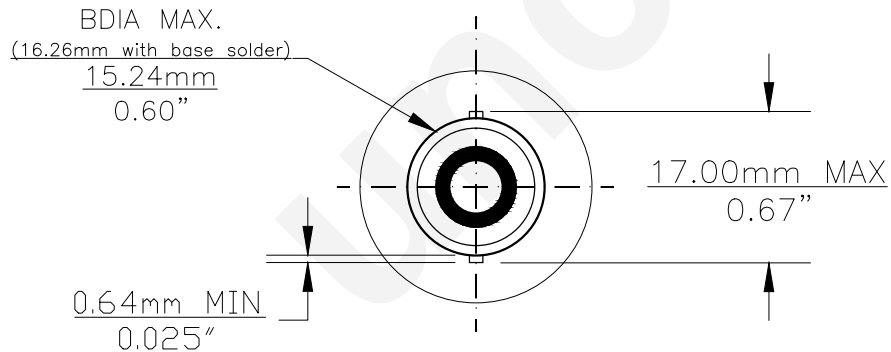

PART NO.	BASE TYPE	DESIGN VOLTS	DESIGN AMPS	MSCD	FILAMENT TYPE	AVERAGE LIFE HOURS	REVISIONS			
							REV #	DESCRIPTION	DATE	APPROVED
1156A	S.C. Bayonet (BA15s)	12.8V	2.10±5%	24±30%	C-6	1200	1	ISSUED	05/19/2014	R.M.

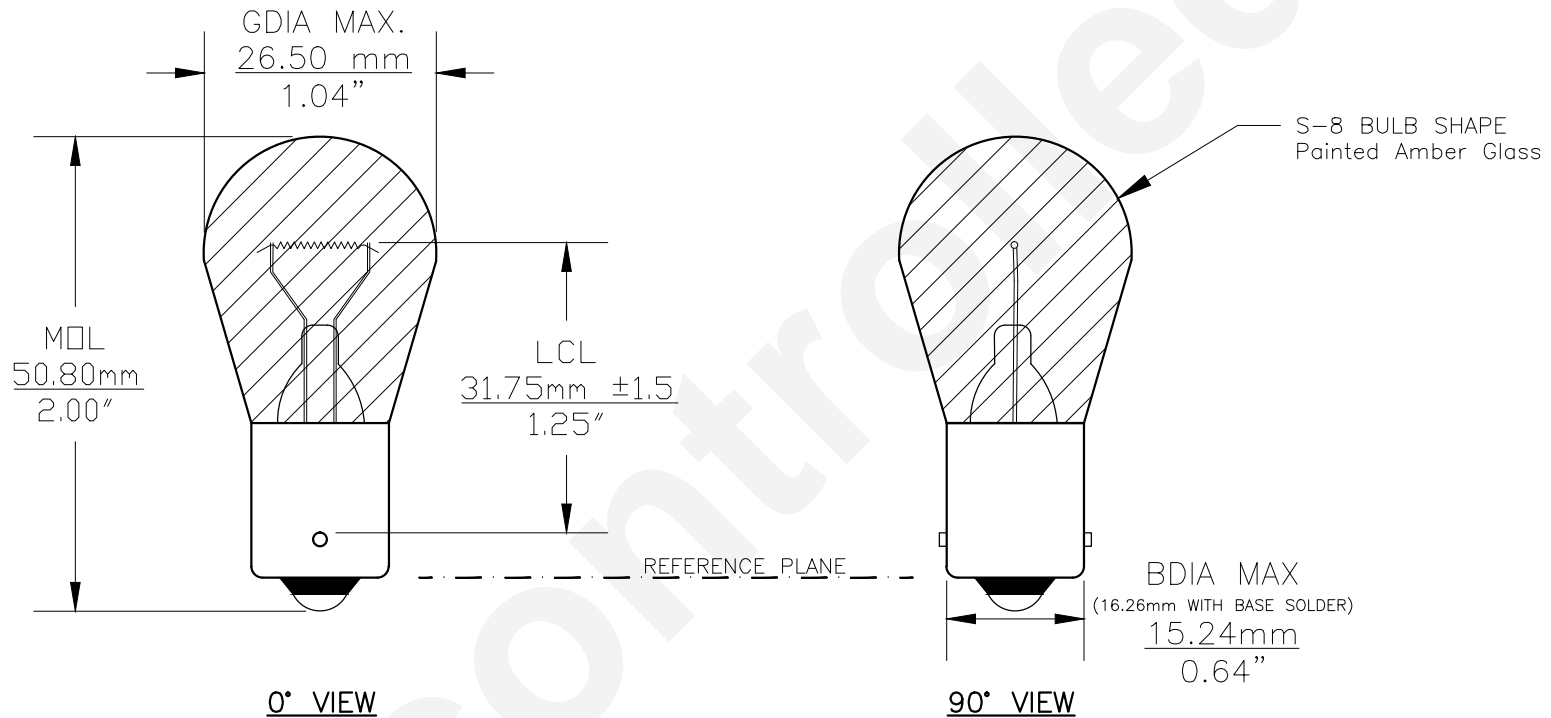

UNLESS OTHERWISE SPECIFIED: DIMENSIONS ARE IN INCHES TOLERANCES		CEC INDUSTRIES LTD			
DECIMALS	ANGULAR	599 BOND STREET		LINCOLNSHIRE, IL 60069	
.XX ± .05	± 0.5°	TITLE LIGHT BULB NO. 1156A			
.XXX ± .010		SIZE A	FSCM NO.	DWG NO. 1156A	REV 1
FRACTIONAL	±1/64	CHECKED	SCALE	PLOT SCALE	SHEET 1 OF 1
DRAWN ROSE MEDINA DATE 05/19/2014		MATERIAL			
FILE 1156A.pdf		DRAWING NOT TO SCALE			